

ALIS SYSTEM

EXAMPLES OF USAGE



ALIS Tech

400+
realized
projects

100+
customers

14
partners
across the
Europe



ABOUT ALIS TECH

ALIS Tech s.r.o. is a company looking at the safety of an operation of medium to large companies from a whole different perspective. We aim to create and ensure a safe working environment avoiding any possible accidents. We base our solutions on the latest technologies defining the direction of Industry 4.0 and implement digitalization trends into so-called blind spots to eliminate operational blindness.

ALIS Tech is founded on years of experience of mother company Aledo s.r.o., which focuses on selling conventional technologies of HSE systems and industrial identifications. Neverending costly renewal of safety marking made with paint or stickers made us arrive at a new thought - the use of LED technology for illumination of safety symbols. We improved the vision of an autonomously safe operation by implementing an anti-collision system securing the safety of pedestrians, material handling technology, and company property. **ALIS Tech's** third division are systems for optimization and revealing critical spots in the operation, enabling the organization of work in real-time.

„We initiated a co-operation with ALIS Tech s.r.o. with a project aiming to increase the safety of transporting suspended loads. We equipped all cranes with LED projectors which alert anyone nearby by illuminating a safety symbol on the floor saying „Attention, moving suspended load“. We hold services and products of ALIS Tech in high regard which is why our cooperation has grown since its beginning. We decided to implement intelligent parabolic mirrors switching using microwave sensors, which lead to even more increased safety of our indoor transport. Our cooperation now spans over several years and we are looking forward towards the next extension of our anti-collision system.“

Petr Mrázek, head of dept. occupational safety and health
Continental Barum s.r.o., Czechia



„We started to cooperate with ALIS Tech s.r.o. intending to improve safety in our operation. Thanks to their smart solutions - specifically built-in LED projectors in a parabolic mirror and safety LED marking for cranes we managed to eliminate operational blindness and increase the clarity of crossroads and space near suspended loads.“



Pavel Šmída, Head of Stamping shop
Hyundai Motor Manufacturing Czech s.r.o., Czechia

„ALIS Tech s.r.o. got us interested due to its unique solution for safety in near to suspended loads. We initiated a co-operation that has been growing continuously. Their innovative solutions in HSE systems are what defines ALIS Tech and why we follow their work.“

Čeněk Šlachta, Health, Safety & Environment Manager
Metso Czech Republic, s.r.o., Czechia



innovative LED floor marking



LED YOUR SAFETY SHINE

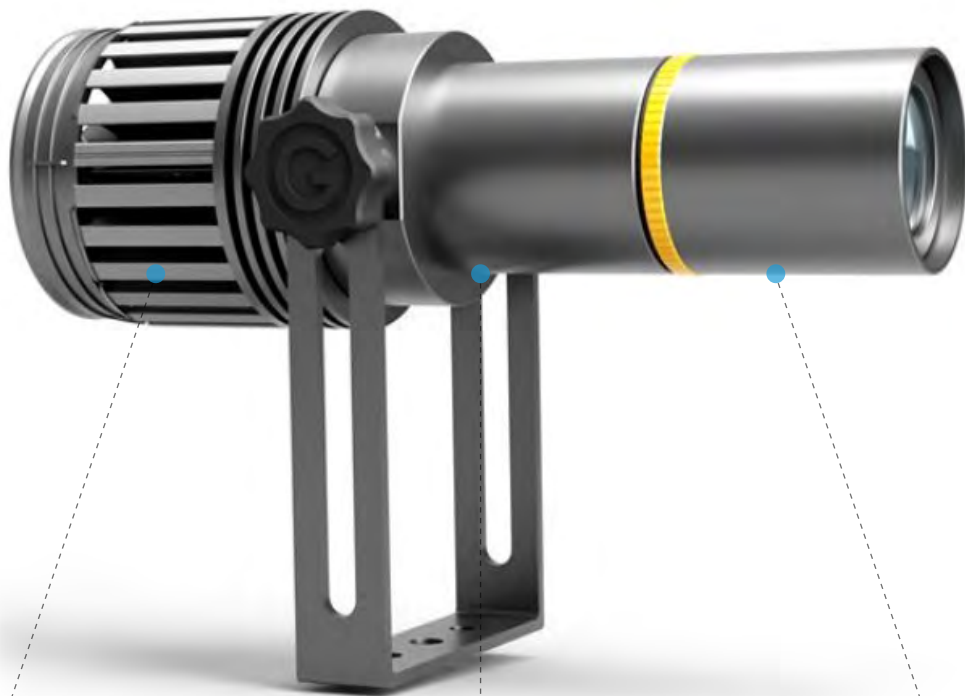

industrial design suitable to all kinds of operation

- active/passive cooling;
- -30 °C to + 35 °C;
- suitable for humid and dusty environment;



wide range of different optics

- from 8 ° to 40 ° optics;
- with higher resolution;
- differs according to the environment;



wide range of ISO safety symbols

- ISO symbols;
- custom symbols;
- large symbols ex. pedestrian crossing;

ADVANTAGES OF LED FLOOR MARKING

ELIMINATION OF OPERATIONAL BLINDNESS AND NEAR-MISSES

The safety symbol can either blink, pulse or shine non-stop. Smart activation eliminates operational blindness and reduces work accidents and near misses related to busy traffic.

LED floor marking technology is suitable for marking moving loads especially of the EOT cranes and Green Tire Transport Systems. A projected sign warns of a motion and indicates a position of the hook/load to personnel and other motorized traffic near the crane.

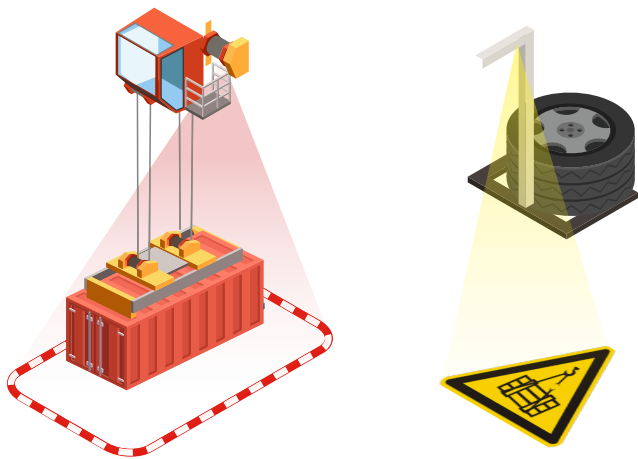

INTEGRATION TO PARABOLIC MIRROR

The built-in LED projector into the parabolic mirror eliminates the disadvantage of the passive character. The LED projector is triggered by the motion of subjects involved in the intersection.

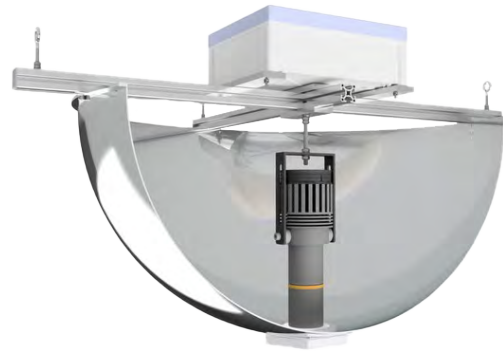

1,25 YEAR RETURN ON INVESTMENT

The LED projected sign can not be covered, overlaid, or destroyed by a movement of material handling equipment. **The ROI is in general 1,25 year.**



polyester laminated tape on the highly frequented place

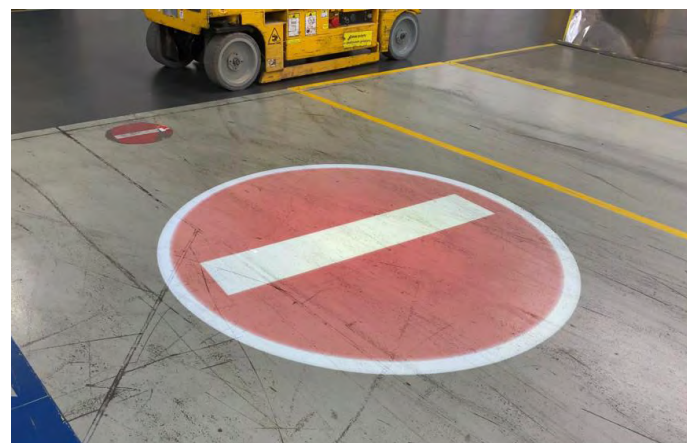

LED projected sign

innovative LED floor marking



EXAMPLES OF USAGE

01

MOVING OBJECTS - INDUSTRIAL MARKING FOR EOT CRANE

A projected sign warns of a motion and indicates a position of the hook/load to personnel and other motorized traffic near the crane. The size of the final illuminated symbol is set according to the size of the burden. The shape of the safety symbol can either be circular or rectangular - depending on the shape of the load. The projection of hazardous zone around the load can be visible only in case the crane is moving.

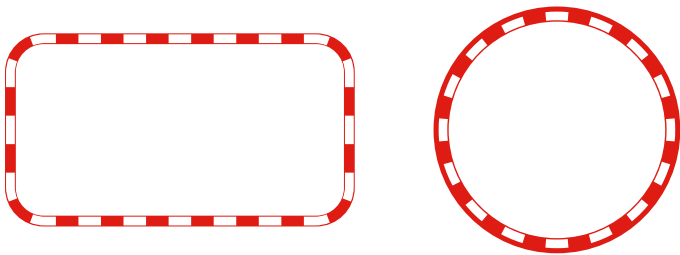

02

LARGE SYMBOLS - PEDESTRIAN CROSSING

The wide portfolio offers large size symbols like „pedestrian crossing“ or symbols made from more than one sign. The size of the final symbol on the floor depends on the installation height of the projector. For example: 10 m installation height - 600 cm diameter of the symbol for 1 projector.

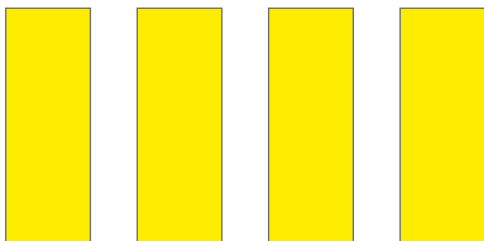

03

STANDARD ISO SYMBOLS OR CUSTOM DESIGNS

All kinds of ISO standard symbols are available, even own custom design such as the company logo or the combination of standard symbols in one.

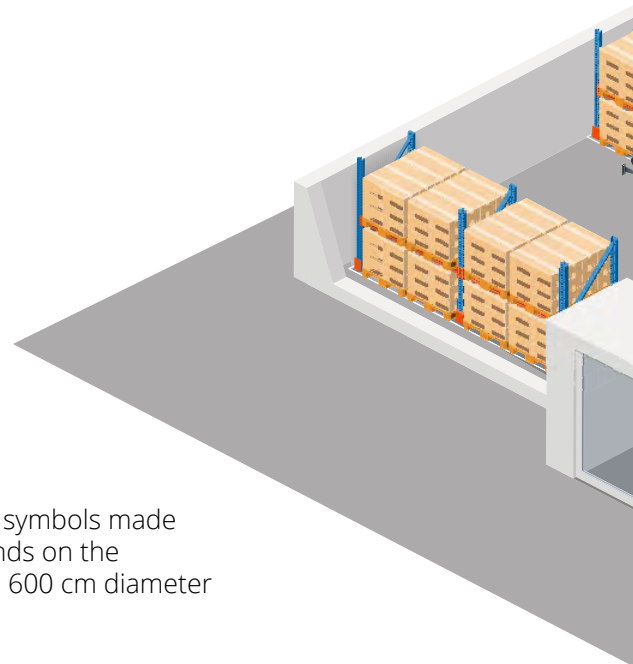



POSSIBLE FEATURES OF LED FLOOR MARKING



activation by a motion/movement

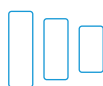

blinking or pulsing



non-stop shining (24/7)

anti-collision system



ACCIDENT-FREE WORKPLACE



outdoor/indoor use

- industrial design;
- use indoor/outdoor;



from fleet to fleet

- connectable to all electric MHE manufacturers;
- connectable to all kinds of MHE;



connected to floor marking

- activated by movement of the MHE;
- activated by movement of pedestrian;

USED TECHNOLOGY AND BASIC COMPONENTS

ULTRA WIDE BAND TECHNOLOGY

Solutions are built on UWB wireless technology (UWB). The UWB is the only reliable technology used for indoor use. In compare of other wireless technologies like Wi-Fi, BLE or GPS the UWB is the most precise one with accuracy up to 50 cm.

VEHICLE TAG

Vehicle tag features 2 possible variants (Tab. A), based on the degree of compatibility with other system features. The selection of the suitable tag depends on the size of the fleet and required degree of safety.

FUNCTIONALITY	VEHICLE TAG	
	AWL-V-1	AWL-V-3
activation of electric devices	●	●
deceleration in zones		●
deceleration against pedestrians		●

Tab. A

ZONE READER

The selection of the reading device (Tab. B) variant depends on the type of forklift tag and required functionalities.

FUNCTIONALITY	ZONE READER	
	AWR-03A	AWR-03B
activation of LED projector	●	
deceleration in zones	●	●
reacts to pedestrian tag	●	

Tab. B

PERSONAL TAG

The personal tag is available as a wrist band in ATEX certified variant - suitable for explosive environments.

OPTOACOUSTIC SIGNALIZATION INSIDE A CABIN

The anti-collision system includes the signalization of a potential danger inside the vehicle cabine. A danger signal is available in two variants: A) immune button B) light beacon.

A) IMMUNE BUTTON



B) LIGHT BEACON





less accidents
& more
efficient hours

TOYOTA

ON THIS SIDE!

EXAMPLES OF USAGE

01

FORKLIFT ANTI-COLLISION SYSTEM

Autonomous deceleration of MHE to the minimum possible speed in order to prevent a collision. Notification to drivers inside the cabin by opto-acoustic signalization.



transferable from
fleet to fleet



autonomous speed
deceleration

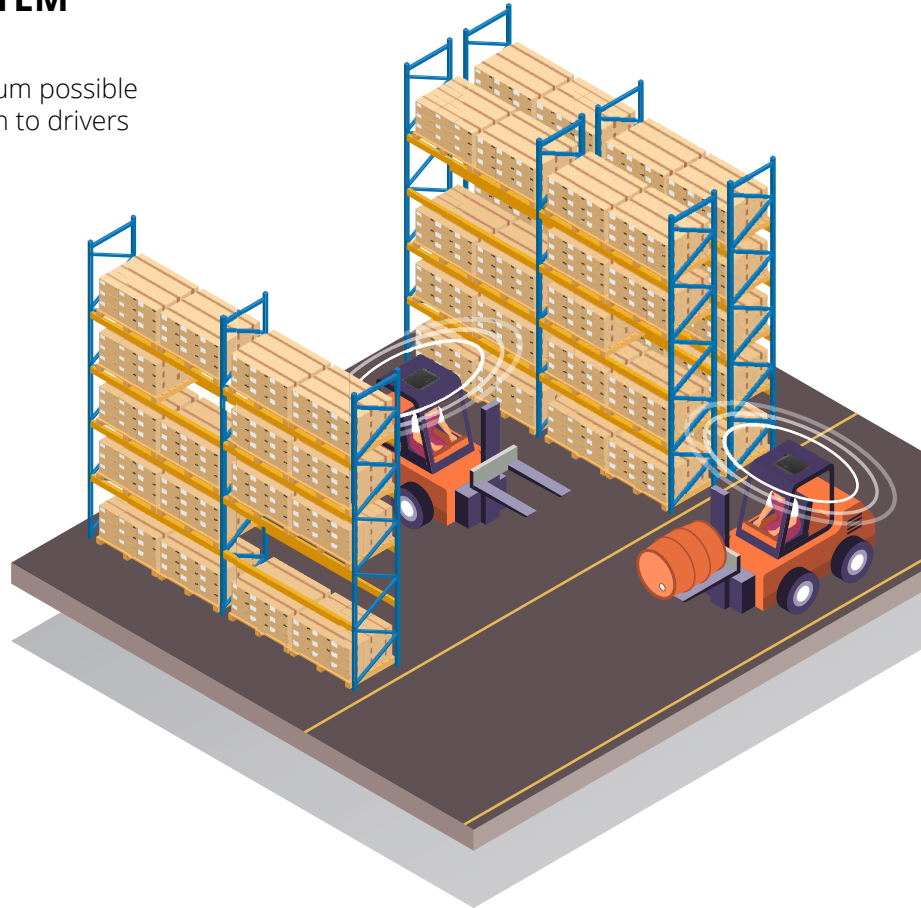

02

PEDESTRIAN ANTI-COLLISION SYSTEM

Autonomous reduction of speed of MHE when dangerously close to pedestrians. Active notification of pedestrians using personal tag to the drivers by using optoacoustic signalization inside the cabine.



pedestrian
interactive protection



elimination of
operational blindness

03

SMART FLOOR MARKING

Projection of safety signs triggered by motion of MHE based on wireless communication between vehicle tag and the reading device on LED projector.



elimination of operational blindness



reduction of near misses

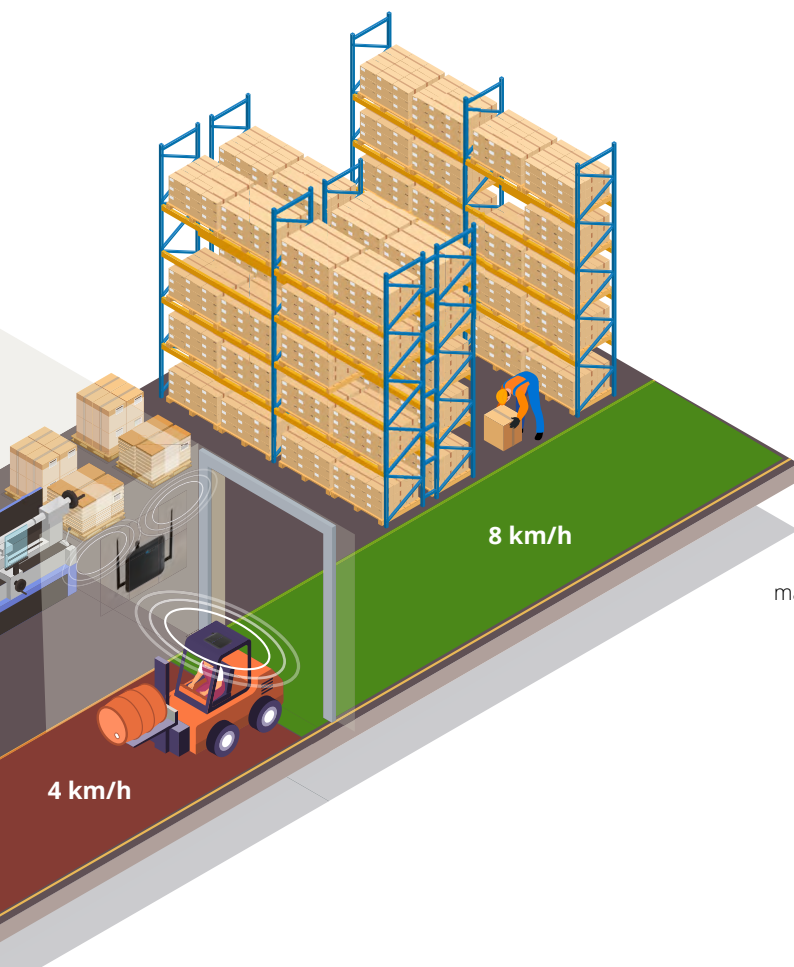
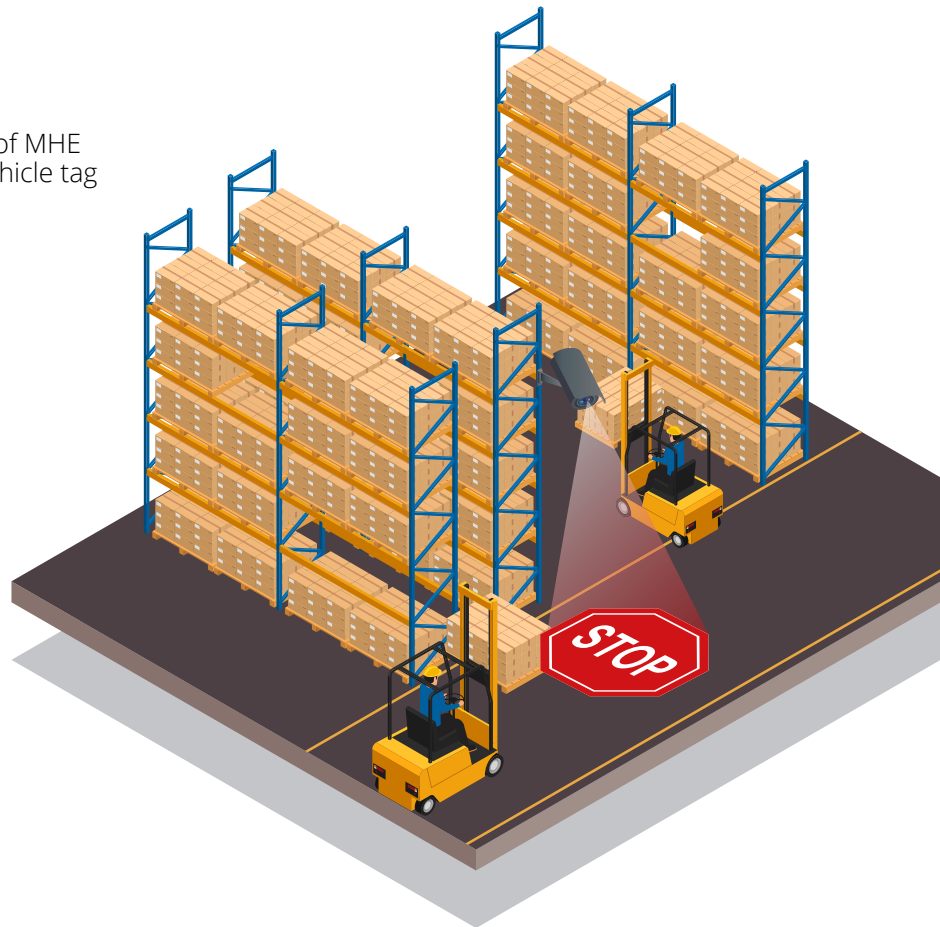

04

DECELERATION IN ZONES

Autonomous deceleration in zones based on the direction of movement to prevent collisions of MHE and pedestrians/other MHE in frequented spots (e.g. production).



speed deceleration to maximum predefined one



detection of travel direction

EXAMPLES OF USAGE

05

DECELERATION IN CRITICAL ZONE

Autonomous deceleration to the required speed upon entering a critical zone with subsequent acceleration to the original speed.



speed presetting in hazardous zone



reduction of near misses

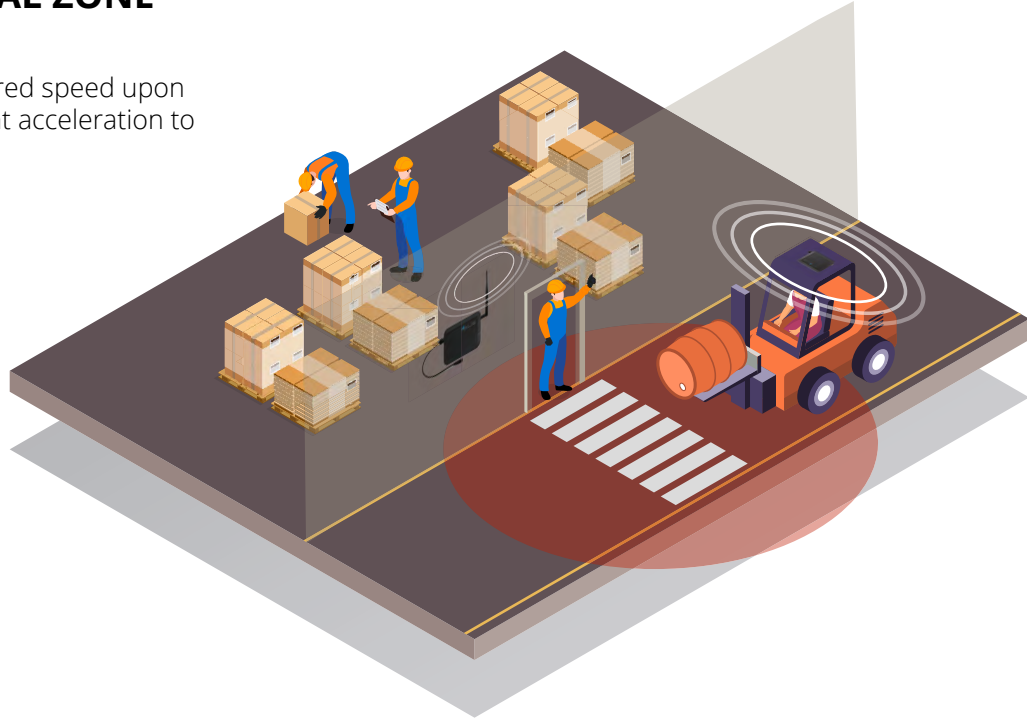

06

SAFETY ANTI-COLLISION BAR

Timely interactive alert of excessively loaded cargo. The safety anti-collision bar is equipped with acoustic signalization by siren and LED light spots.



110 dB
lasting 7 sec



LED lights signaling
the potential of collision

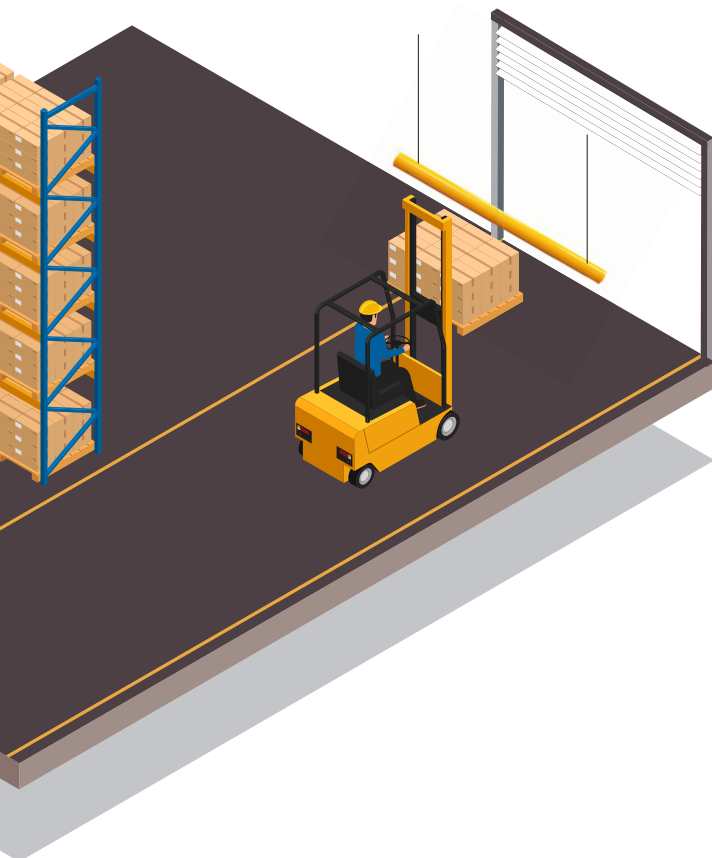

RAL 1021



140 mm

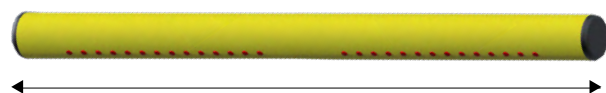

2 000 mm

CONNECTIVITY OF FEATURES

REQUIRED USAGE	TAG			RAEDER	
	AWL-V-1	AWL-V-3	AWL-07-AS	AWR-03A	AWR-03B
anti-collision of forklift vs forklift		●			
anti-collision of forklift vs pedestrian		●	●		
PJ activation by forklift motion	●	●		●	
PJ activation by pedestrian movement			●	●	
deceleration of forklift in a zone		●		●	●
complex anti-collision solution (all in one)		●	●	●	

Tab. C



safe zone



warning zone - forklift autonomously decelerates, personal tag vibrates



warning zone - connectivity to LED floor marking (symbol changing)

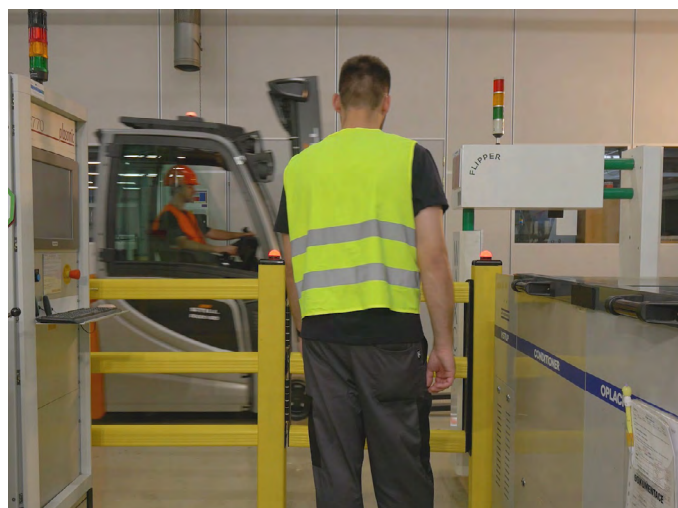

danger zone - magnetic lock

PARTNERSHIP NETWORK



„We consider ALIS Tech a young, innovative and dynamic company with a very high technological capability and great fresh flexibility to develop tailor suit industrial solutions for our customers. In NOSIA SRL we are very happy with our partnership. We assure will grow together in a wide range of industrial areas like Nuclear Power Industries, Petrochemical, Automotion, Paper&Pulp industry, food industries, pharma and power plants.“

Sergio Cadenas, NOSIA SRL, Spain

„Collaborating with the company ALIS Tech has enabled Fitelec Prévention to enter the 4.0 era of safety and prevention equipment and to offer its customers in the industrial and logistics sector an innovative and complementary offer. ALIS Tech is responsive and attentive to each project, to each partner and regularly researches what is new in the prevention and safety market, in order to offer them to us. Their philosophy is similar to ours: the customer is at the center of the relationship and we love our customers.“



Julie Bellanger, Fitelec Prévention, France



„Very professional and flexible staff with new and inovative solutions for work safety environment! I really recommend this company to work with!“

Martynas Paulatis, SDG Kodas, Lithuania



„We highly appreciate our co-operation with ALIS Tech. ALIS Tech supply, without a question, the best products on the market within eg. anti-collision systems and LED visualization. No matter what challenge we face, ALIS Tech is always helpful in finding the best solution to this. For the benefit of both us as distributor and our customers.“

In short - ALIS Tech. always delivers high quality products and services.“

Thomas Vestergaard, ECK, Denmark

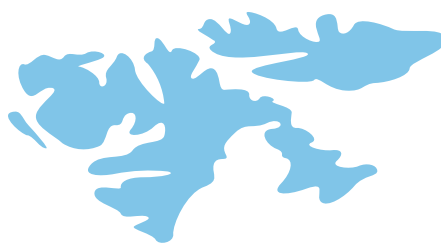

„Thanks to ALIS Tech s.r.o. we have become a leader in innovative safety on the domestic Slovak market. We deliver tailored suit solutions to customers. Thanks to the complexity of the ALIS system, we can work closely with the forklift manufacturers STILL and Jüngerich.

Ing. Martin Ševčík, Aledo.sk, Slovakia



FIRST CLASS IN SAFETY BE PART OF IT

SELECTED REFERENCES



ŠKODA

VOLVO



HYUNDAI

SIEMENS

Continental®

faurecia



Hydro



Nestlé

Good Food, Good Life

+ 100 ...

ALIS Tech s.r.o.

TUŘANKA 1222/115, SLATINA, 627 00 BRNO CZ

T: +420 739 233 985, E: info@alis-tech.com

www.alis-tech.com



EUROPEAN UNION
European Regional Development Fund
Operational Programme Enterprise
and Innovations for Competitiveness